



azeta new

finiture / finishes / finitions / ausföhrungen / acabados

.015
Cromo
Chrome
Chromé
Verchromt
Cromado





AA830401

AA870110

AA830101
BOX PCS. 12

Kg. 2,0



Miscelatore monocomando per lavabo con scarico 1"1/4 con flex inox cm 50 att. 3/8" F.

Single lever washbasin mixer with 1"1/4 pop-up waste and 3/8" F flex. hoses cm 50.

Mitigeur de lavabo avec vidage automatique 1"1/4 et flexibles d'alimentation cm 50 3/8" F.

Einhebelmischer Waschtischbatterie mit Ablaufgarnitur 1"1/4 und flex. Anschlussschläuchen cm 50 3/8" F.

Monomando para lavabo con desagüe 1"1/4, tubo flexible inoxidable de 50 cm, empalme 3/8" F.

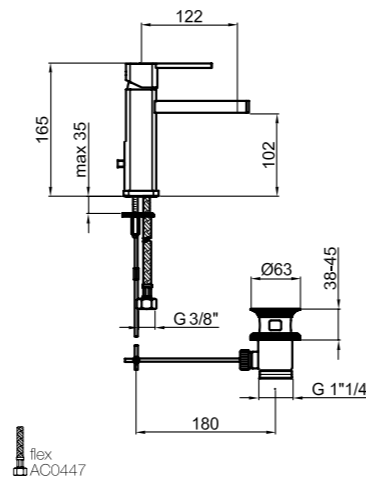

flex
AC0447

AC0470015 Ø 25 mm
AC0355000

AA830102

.015 Cromo / Chrome / Chromé / Verchromt / Cromado

AA830401
BOX PCS. 4

Kg. 3,2



Miscelatore monocomando per lavabo alto con scarico up & down; flex inox cm 70 att. 3/8" F.

High single lever washbasin mixer with up & down pop-up waste, with 3/8" flex. hoses 70 cm.

Mitigeur de lavabo haut avec vidage up & down, flexibles d'alimentation cm 70 3/8" F.

Einhebelmischer Waschtischbatterie, mit Ausführung, mit up & down Ablaufgarnitur, mit Flex. Anschlussschläuchen cm 70 3/8" F.

Monomando para lavabo alto con valvula click-clack, tubo flexible inoxidable de 70 cm, empalme 3/8" F.

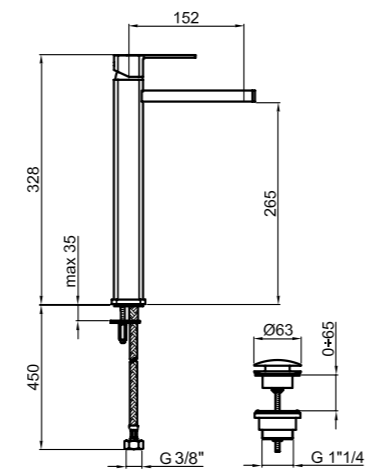

flex
AC0448

AC0470015 Ø 25 mm
AC0355000

AA830402

.015 Cromo / Chrome / Chromé / Verchromt / Cromado

AA830606
BOX PCS. 12

Kg. 2,4



Miscelatore monocomando per lavabo incasso muro, con piastra orizzontale, senza scarico e flessibili.

Concealed single lever washbasin mixer, horizontal cover plate, without pop-up waste and flex hoses.

Mitigeur de lavabo à encastrer, rosace horizontale, sans vidage et flexibles.

Einhebelmischer Unterputz-Waschtischbatterie waagerechte Rosette, ohne Ablaufgarnitur und flex. Anschlussschläuchen.

Monomando empotrable para lavabo de pared, con placa horizontal, sin desagüe ni tubos flexibles.

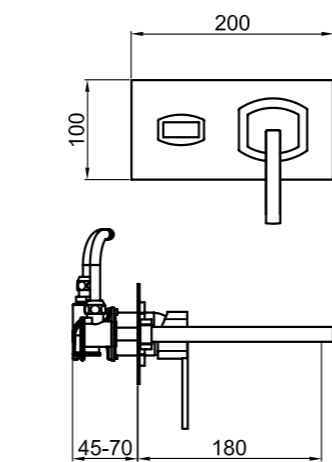

AC0356015

AC0470015 Ø 35 mm
AC0355000

.015 Cromo / Chrome / Chromé / Verchromt / Cromado

AA880101
BOX PCS. 12

Kg. 2,4



Miscelatore monocomando per doccia incasso, con piastra, senza flessibile, doccetta e gancio.

Concealed single lever shower mixer with cover plate, without shower set.

Mitigeur de douche à encastrer avec rosace, sans garniture de douche.

Einhebelmischer Unterputz-Brausebatterie, mit Rosette ohne Brausegarnitur.

Monomando empotrable para ducha, con placa, sin tubo flexible, ducha ni gancho.

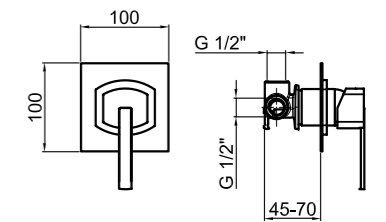

AC03590015

Ø 35 mm
AC0338000

.015 Cromo / Chrome / Chromé / Verchromt / Cromado

AA860101
BOX PCS. 12

Kg. 2,3



Miscelatore monocomando per vasca incasso, con deviatore, piastra; senza flessibile doccetta e gancio di supporto.

Concealed single lever bath mixer with diverter, cover plate, without shower set.

Mitigeur bain-douche à encastrer avec inverseur, rosace, sans garniture de douche.

Einhebelmischer Unterputz-Badebatterie mit Umstellung, Rosette, ohne Brausegarnitur.

Monomando empotrable para bañera, con desviador, placa, sin tubo flexible, ducha ni gancho de soporte.

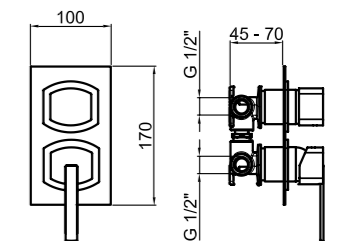

Ø 35 mm
AC0338000

AC0329000 AC0357015

.015 Cromo / Chrome / Chromé / Verchromt / Cromado

AA840101
BOX PCS. 12

Kg. 1,8



Miscelatore monocomando per bidet con scarico 1"1/4 con flex inox cm 50 att. 3/8" F.

Single lever bidet mixer with 1"1/4 pop-up waste and 3/8" F flex. hoses cm 50.

Mitigeur de bidet avec vidage automatique 1"1/4 et flexibles d'alimentation cm 50 3/8" F.

Einhebelmischer Bidetbatterie mit Ablaufgarnitur 1"1/4 und flex. Anschlussschläuchen cm 50 3/8" F.

Monomando para bidé con desagüe 1"1/4, tubo flexible inoxidable de 50 cm, empalme 3/8" F.

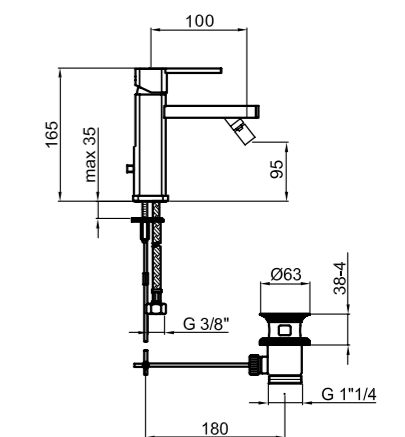

flex
AC0447

AC0467015 Ø 25 mm
AC0355000

.015 Cromo / Chrome / Chromé / Verchromt / Cromado

AA840102