

sax

finiture / *finishes* / finitions
Ausführungen / acabados

.015
Cromo
chrome
chromé
verchromt
cromado



sax

■ SX830101

box pcs. 12



Miscelatore monocomando per lavabo con scarico 1"1/4 con flex inox cm 37 att. 3/8" F.

Single lever washbasin mixer with 1"1/4 pop-up waste and 3/8" F flex. hoses cm 37.

Mitigeur de lavabo avec vidage automatique 1"1/4 et flexibles d'alimentation cm 37 3/8" F.

Einhebelmischer Waschtischbatterie mit Ablaufgarnitur 1" 1/4 und flex. Anschlussschläuchen cm 37 3/8" F.

Monomando para lavabo con desagüe 1" 1/4, tubo flexible inoxidable de 37 cm, empalme 3/8" F.

10 SX830104 1/2 SX830102

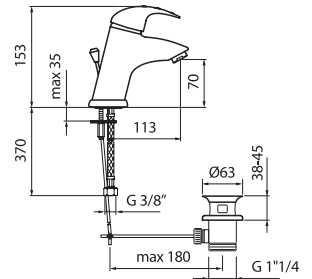

■ SX840101

box pcs. 12



.015 Cromo / chrome / chromé
verchromt / cromado

Ø 40 mm
AC0370000

Miscelatore monocomando per bidet con scarico 1"1/4 con flex inox cm 37 att. 3/8" F.

Single lever bidet mixer with 1"1/4 pop-up waste and 3/8" F flex. hoses cm 37.

Mitigeur de bidet avec vidage automatique 1"1/4 et flexibles d'alimentation cm 37 3/8" F.

Einhebelmischer Bidetbatterie mit Ablaufgarnitur 1" 1/4 und flex. Anschlussschläuchen cm. 37 3/8" F.

Monomando para bidé con desagüe 1" 1/4, tubo flexible inoxidable de 37 cm, empalme 3/8" F.

10 SX840104 1/2 SX840102

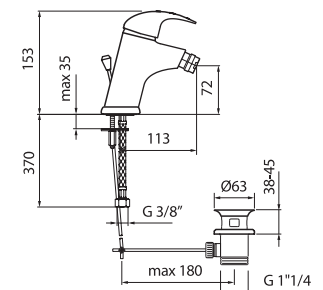

■ SX831301

box pcs. 12



.015 Cromo / chrome / chromé
verchromt / cromado

Ø 40 mm
AC0370000

Miscelatore monocomando per lavabo con scarico 1"1/4 con flex inox cm 37 att. 3/8" F.

Single lever washbasin mixer with 1"1/4 pop-up waste and 3/8" F flex. hoses cm 37.

Mitigeur de lavabo avec vidage automatique 1"1/4 et flexibles d'alimentation cm 37 3/8" F.

Einhebelmischer Waschtischbatterie mit Ablaufgarnitur 1" 1/4 und flex. Anschlussschläuchen cm 37 3/8" F.

Monomando para lavabo con desagüe 1" 1/4, tubo flexible inoxidable de 37 cm, empalme 3/8" F.

10 SX831304 1/2 SX831302

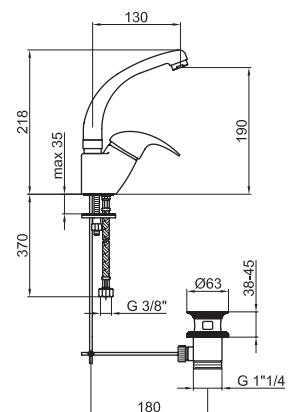

.015 Cromo / chrome / chromé
verchromt / cromado

Ø 40 mm
AC0370000

■ SX850101

box pcs. 12

new

Miscelatore monocomando per vasca esterno completo con flessibile in ottone da 150 cm, doccia e supporto.

Single lever bath mixer with shower set complete of brass hose 150 cm, handshower and holder.

Mitigeur bain-douche complet de flexible 150 cm, douchette et support mural.

Einhebelmischer Badebatterie mit Brausegarnitur bestehend aus Metall-Brauseschlauch 150 cm, Handbrause und Wandhalterung.

Monomando esterno para bañera completo, con tubo flexible de latón de 150 cm, ducha a prueba y soporte.

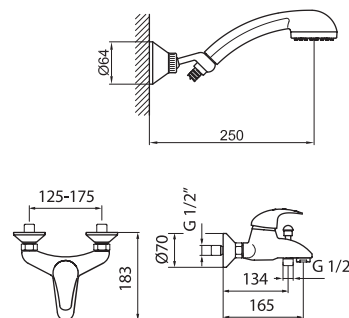

.015 Cromo / chrome / chromé
verchromt / cromado

153
+ € 15,00

Ø 40 mm
AC0370000

■ SX850102

box pcs. 12

Miscelatore monocomando per vasca esterno; senza flessibile, doccia e gancio di supporto.

Single lever bath mixer without shower set.

Mitigeur bain-douche sans garniture de douche.

Einhebelmischer Badebatterie ohne Brausegarnitur.

Monomando esterno para bañera, sin tubo flexible, ducha ni gancho de soporte.

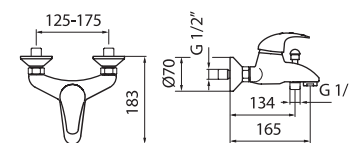

.015 Cromo / chrome / chromé
verchromt / cromado

153
+ € 15,00

Ø 40 mm
AC0370000

■ SX860101

box pcs. 12

Miscelatore monocomando per vasca incasso; con deviatore automatico; senza flessibile, doccia e gancio di supporto.

Concealed single lever bath mixer with automatic diverter, without shower set.

Mitigeur bain-douche à encastrer avec inverseur automatique, sans garniture de douche.

Einhebelmischer Unterputz-Badebatterie mit Umstellung, ohne Brausegarnitur.

Monomando empotrable para bañera, con desviador automático; sin tubo flexible, rociador ni soporte.

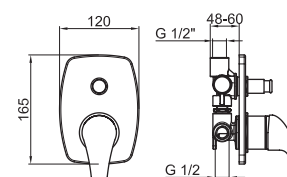

.015 Cromo / chrome / chromé
verchromt / cromado

AC0382015

Ø 40 mm
AC0370000

■ AC0365

box pcs. 12



Bocca d'erogazione senza deviatore per vasca incasso; attacco da 3/4".

Spout for concealed bath mixer, 3/4" connection.

Bec pour mitigeur bain/douche encastré, attache 3/4".

Gussauslauf für Unterputz-Badebatterie, 3/4" Anschluss.

Boca de erogación sin desviador para bañera empotrable; conexión 3/4".

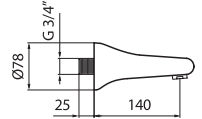

■ SX870102

box pcs. 12



.015 Cromo / chrome / chromé
verchromt / cromado

Miscelatore monocomando per doccia esterno; senza flessibile, doccetta e gancio di supporto.

Single lever shower mixer without shower set.

Mitigeur de douche sans garniture de douche.

Einhebelmischer Brausebatterie ohne Brausegarnitur.

Monomando esterno para ducha, sin tubo flexible, ducha ni gancho de soporte.

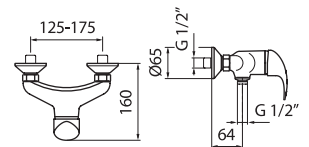

■ SX880101

box pcs. 16



.015 Cromo / chrome / chromé
verchromt / cromado

Miscelatore monocomando per doccia incasso, con piastra, senza flessibile, doccetta e gancio.

Concealed single lever shower mixer with cover plate, without shower set.

Mitigeur de douche à encastrer avec rosace, sans garniture de douche.

Einhebelmischer Unterputz-Brausebatterie, mit Rosette ohne Brausegarnitur.

Monomando empotrable para ducha, con placa, sin tubo flexible, ducha ni gancho.

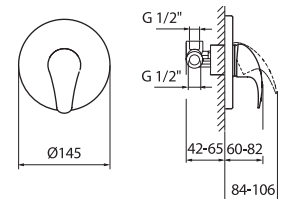

153
+ € 15,00

Ø 40 mm
AC0370000

.015 Cromo / chrome / chromé
verchromt / cromado

AC0416015

Ø 40 mm
AC0370000

- **SX921301**
- **SX920201**
box pcs. 12



Miscelatore monocomando per lavello inclinato, bocca fusa / idroformata orientabile a 360° e flessibili cm 37 3/8" F.

Single lever sink mixer, goose neck and cast / forged swivel spout, with 3/8" F flex. hoses cm 37.

Mitigeur d'évier série avec bec mobile coulé/idroformée et flexibles d'alimentation cm 37 3/8" F.

EHM Stand-Spültischbatterie, Armaturensérie, mit schwenkbarem Gussauslauf / Auslauf und flex. Anschlussschläuchen cm. 37 3/8" F.

Monomando para fregadero inclinado, caño fundido / hidroformado orientable 360° y tubos flexibles de 37 cm, 3/8" F.

- 10 SX921304
 - 1/2 SX921302
- 10 SX920204
 - 1/2 SX920202

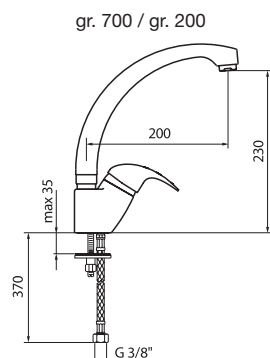

gr. 700 / gr. 200

Ø 40 mm
AC0370000

- gr. 700 **SX921301 .015** Cromo / chrome / chromé verchromt / cromado
- gr. 200 **SX920201 .015** Cromo / chrome / chromé verchromt / cromado

- **SX920101**
box pcs. 12



Miscelatore monocomando per lavello, canna orientabile a 360° e flessibili cm 37 3/8" F.

Single lever sink mixer, swivel spout, with 3/8" F flex. hoses cm 37.

Mitigeur d'évier avec bec mobile et flexibles d'alimentation cm 37 3/8" F.

EHM Stand-Spültischbatterie, mit schwenkbarem Auslauf und flex. Anschlussschläuchen cm 37 3/8" F.

Monomando para fregadero, caño orientable 360° y tubos flexibles de 37 cm, 3/8" F.

- 10 SX920104
- 1/2 SX920102

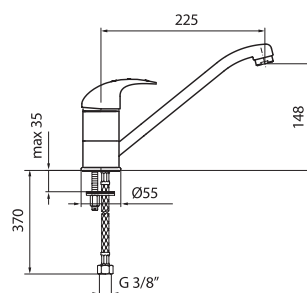

Ø 40 mm
AC0370000

- **SX910101**
box pcs. 12



.015 Cromo / chrome / chromé verchromt / cromado

Miscelatore monocomando lavello a parete, bocca orientabile idroformata cm 20.

Wall mounted single lever sink mixer with forged swivel spout.

Mitigeur mural d'évier série avec bec idroformée mobile.

EHM Wand-Spültischbatterie Armaturensérie, mit schwenkbarem Auslauf.

Monomando fregadero de pared, caño hidroformado orientable de 20 cm.

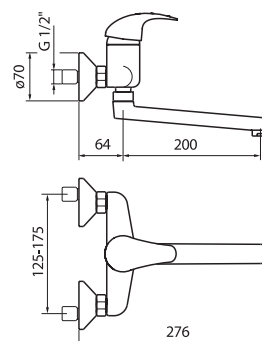

Ø 40 mm
AC0385000

.015 Cromo / chrome / chromé verchromt / cromado